

**INNOVATIVE, COST-EFFICIENT, CUSTOMIZED**  
**Intelligent silo solutions**



**Silo technology**



## ENGINEERING YOUR SUCCESS

**Zeppelin Systems, the world leading plant manufacturer for high quality bulk material and liquids handling, has remarkably grown over the past 60 years. We cover the demands of a wide range of industries and supply all plant manufacturing services from one single source, whether basic engineering, in-house production of components, final assembly or comprehensive customer service. Thanks to our financial strength and our global network we have long been a reliable partner for our customers.**

Every Zeppelin plant is developed according to the clients' specific requirements and realized thanks to our customized innovative processes and technologies.

The knowledge we have acquired over more than 60 years of plant manufacturing and the world's largest network for bulk material handling are the key to providing ideal solutions whatever the challenge. After all, your success is our goal.

### **Zeppelin plant engineering – business fields**

#### **Polymer Plants**

Plants for plastics producers and forwarders

#### **Plastics Processing & Rubber Plants**

Plants for the plastics processing and rubber industry

#### **Reimelt Food Technology**

Plants for the food, confectionery and bakery industry

#### **Henschel Mixing Technology**

Mixers, mixing systems

#### **Silos & Filters**

Silo technology and filters

#### **Components**

Diverter valves, rotary feeders, separators, sifters ...

#### **Customer Service**

Assembly, maintenance, spare parts

#### **Quality Service**

Services in quality management

# CONSISTENTLY BETTER

Silo production has a long tradition at Zeppelin. The company welded tanks from aluminium already in the days of airship construction in the early 20th century.

This special know-how developed into the drive motor for the reframing of Zeppelin's business activities after World War II. The first standard aluminium silo was produced as early as 1950. Other innovations, such as the development of emboxable silos in the 70ies and the technology for easy on-site assembly of silos – even those larger than 500 m<sup>3</sup> – enabled Zeppelin silo technology to grow consistently.



Always near our customers – all around the world



# GLOBAL LEADER

As a world leading plant manufacturer for the handling of high-quality bulk materials, we have excellent know-how in the plastics, chemicals and food industry.



## Scope of delivery

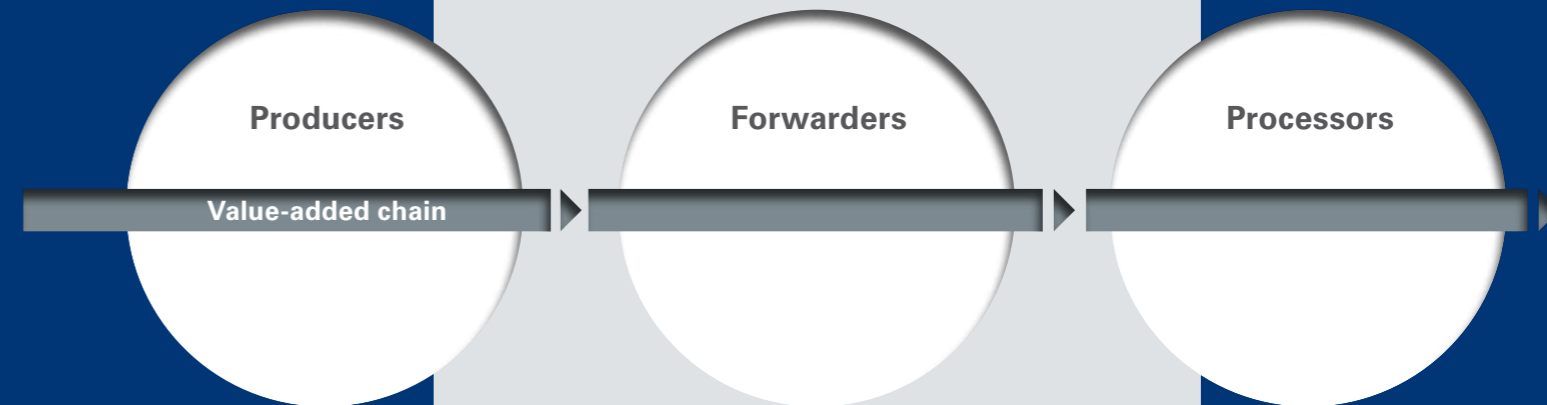

Our scope of delivery depends on the value-added chain of our customers

- Storing
- Conveying
- Blending
- Degassing
- Drying
- Cooling
- Dedusting and processing
- Dosing and weighing
- Packing and loading

We not only offer systems for optimum storage, but develop integrated solutions perfectly adjusted to our customers' processes and methods such as conveying, dosing, blending, dedusting, cooling, degassing, etc. We are active globally in many areas, from the production of bulk materials to logistics and the processing industry. Thanks to our 20 locations worldwide and well-located production facilities in Germany (Friedrichshafen), Belgium, Brazil and Saudi Arabia, we are able to supply all relevant markets in an optimum way on various routes of transport.

# DEFINITELY THE SAFEST CHOICE

With our storage silos made of aluminium or stainless steel, we ensure cost-efficient, dependable and gentle storage of your high-quality bulk materials.

## Reliable operation – optimized design thanks to Zeppelin technology

In order to ensure optimum operation at all times, the correct static and process-related design of the silos is essential.

Our structural engineers consider all the current calculation principles and country-specific regulations, e.g. wind and earthquake loads. Structural explosion protection by means of explosion pressure venting as well as preventative ex-protection by grounding all plant parts and avoiding ignition sources are also part of the portfolio.

With the process-related design of the silos, we avoid bridging and ratholing asymmetrical flow zones, segregation or condensation. In addition, tried and tested anti-honking systems provide for noise-free processes to ensure your operating success. When bulk materials from new manufacturing processes need to be stored, we identify the flow properties in advance reliably on the basis of shear tests.

In many cases, we use our comprehensive range of accessories for our designs. We manufacture or develop these key components ourselves.

Optimized material use by means of FEM calculations

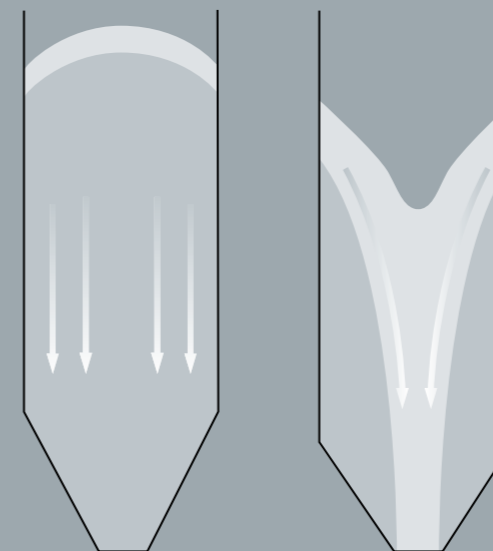
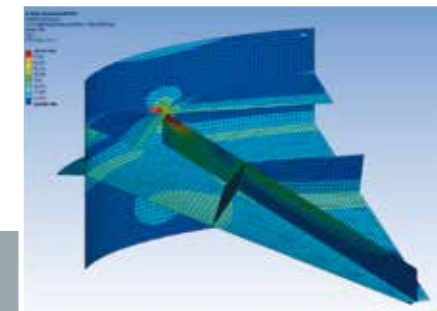

Mass flow (left):  
The entire content of the silo starts to move when the product is discharged.

Funnel flow (right):  
When the product is discharged, only the bulk materials above the output opening start to move; dead zones develop in the cone area.

# A RELIABLE SYSTEM DEPENDS ON THE QUALITY OF ITS COMPONENTS

## This is why we build all essential ones ourselves

To promote quality and to achieve added value are basic requirements for our systems. We develop and produce ourselves all components that are essential to a cost-effective complete system in order to always meet these requirements. Nobody pays more

attention to the important details than the one who conceived the entire system. Tried and tested, state-of-the-art technology, smoothly integrated in your overall concept – this is what you can expect from the Zeppelin components.



## Everything for your silo – special components from Zeppelin



### Zeppelin filter

Fully-automatic venting filter with pneumatic cleaning for continuous dedusting of the pneumatic conveying air of silos. High filtration efficiency with continuously low filter resistance.



### Silo control and monitoring system

For controlling, monitoring, data storage and visualization. Modular construction system, from individual silos to complex silo plants.



### Zeppelin vibratory bottom

In order to activate the product flow and conveying of non-fluidizable bulk materials with poor flowability, horizontal, circular vibrations generated by an unbalanced motor are carried into the product column.



### Zeppelin aeration bottom

The pneumatic aerating system serves as a discharge aid by way of fluidization combined with mechanical movement and allows complete discharge. Especially powdery bulk materials which are easy to fluidize are discharged reliably and very gently. Depending on the requirements, in combination with additional aeration equipment (e.g. fluidizing hoses or pads).

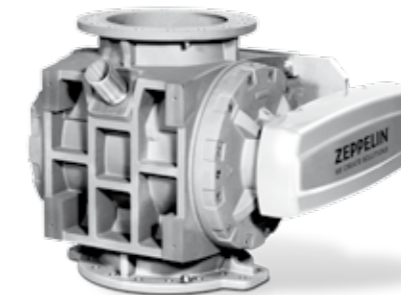

### Zeppelin rotary feeder

Modern concepts provide the raw materials as close to the machines as possible. For conveying the product from external silos to the day bins in the production plant, Zeppelin uses technologies which are both highly efficient and product-gentle.



### Zeppelin vacuum hopper loader

All-purpose device for automatic feeding of pelletized, powdered, and granulated products to silos, hoppers, processing machines and extruders. Low maintenance required thanks to the large filter area with automatic jet cleaning.



## OPTIMUM BLENDING RESULTS

Due to process or raw material fluctuations, it is not always easy in plastics processing or plastics recycling to achieve a consistently high level of product quality. With blending silos from Zepelin, the fluctuations can be offset, which leads to far better results. The standard versions of our broad product range cover a large number of bulk materials and meet most requirements regarding blending performance. Visit our technology center and see for yourself how well-suited our blenders are for your requirements.

**The use of Zepelin blending silos provides many advantages:**

### Reduced energy consumption

Since they are designed as gravity blenders, no additional power is required.

### Saving time

Generally, one cycle is sufficient for the homogenization of the product. For highest requirements, we offer pneumatic recirculation systems for several cycles.

### Low total investment

Since the silos are highly-efficient, it is often possible to use fewer or smaller blenders.

### Neutralization of smell and taste

Every blender can be equipped with aeration and degassing equipment. Cooling, heating, inerting or drying is also possible in our blending silos.

## Selection diagram for blending silos

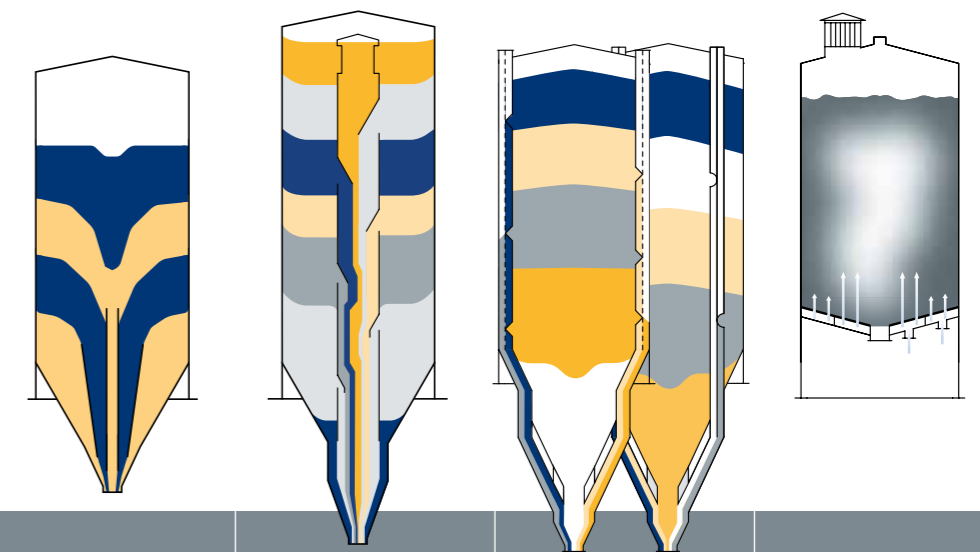

	Multi-Flow	Centro-Blend	Multi-Pipe Multi-Channel	Fluidized Bed Blender
Powders with easy flowability 50 – 500 µm	✓	✓	(✓)	✓
Pellets with easy flowability 200 – 3000 µm	✓	✓	✓	○
Powders with poor flowability	✓	✓		
Blender size [m²] (maximum)	1500	300	3000	1000 (3000)
Type of energy input	gravimetric	gravimetric	gravimetric	pneumatic
Specific energy requirement [kWh/t]	1–3	1–2	<1	1–2

✓ suitable    (✓) of limited suitability    ○ not economic

## Progression of manufacturing fluctuations without and with the use of a blending silo

without blender

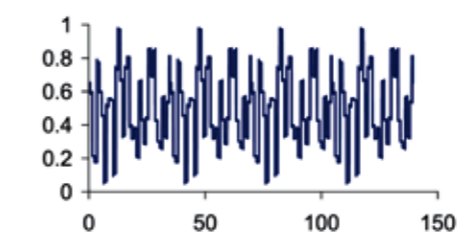

production time [h]

with blender

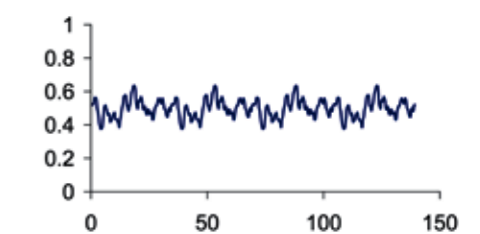

production time [h]

# ALWAYS THE RIGHT CHOICE

Depending on your requirements and the respective product properties, you can choose from several blending concepts. Please consider the following selection criteria:

## Product and flow properties

Powder with poor flowability, pellets or powder with easy flowability? We have the right blending silo for every product property.

## Required homogeneity depending on the blending time

How homogeneously must your product be blended so that it can be processed in an optimum way?

## Cleaning

Do you change products or colors frequently? Then fast and easy blender cleaning is indispensable. After all, you want all batches to remain free of contamination.

## Continuous or discontinuous operation

Do you want to continuously fill in new material for blending and discharge material at the same time or do you want to fill the blender batch-wise and discharge it completely?

## Height-to-diameter ratio

In order to achieve optimum blending results, the suitable ratio must be selected for the blender design.



Typical use of blending silos for the production of polyolefins

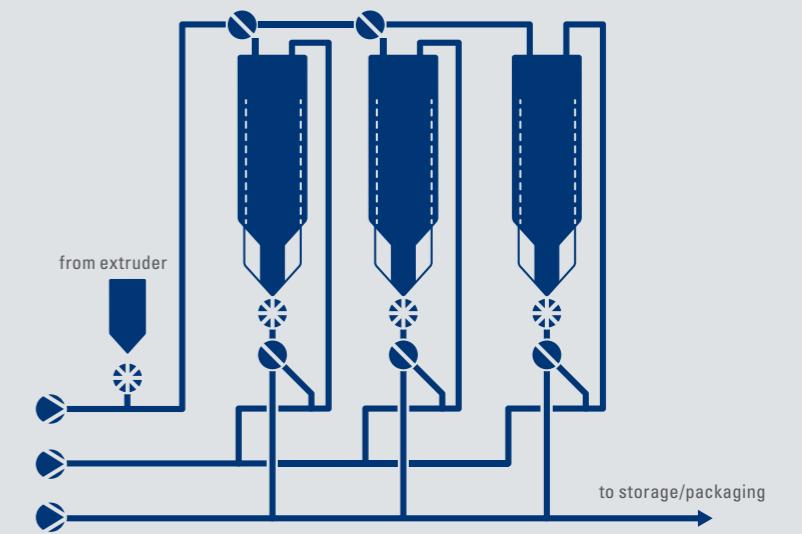

Typical use of blending silos for recycling

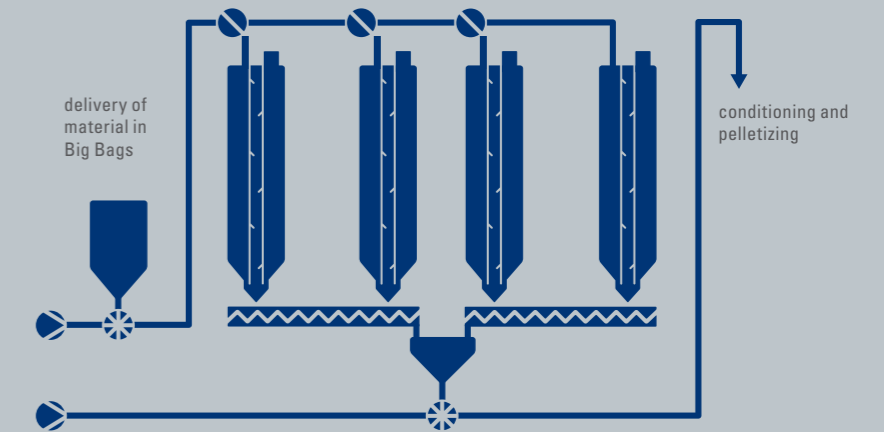

Typical use of blending silos for the processing of PVC

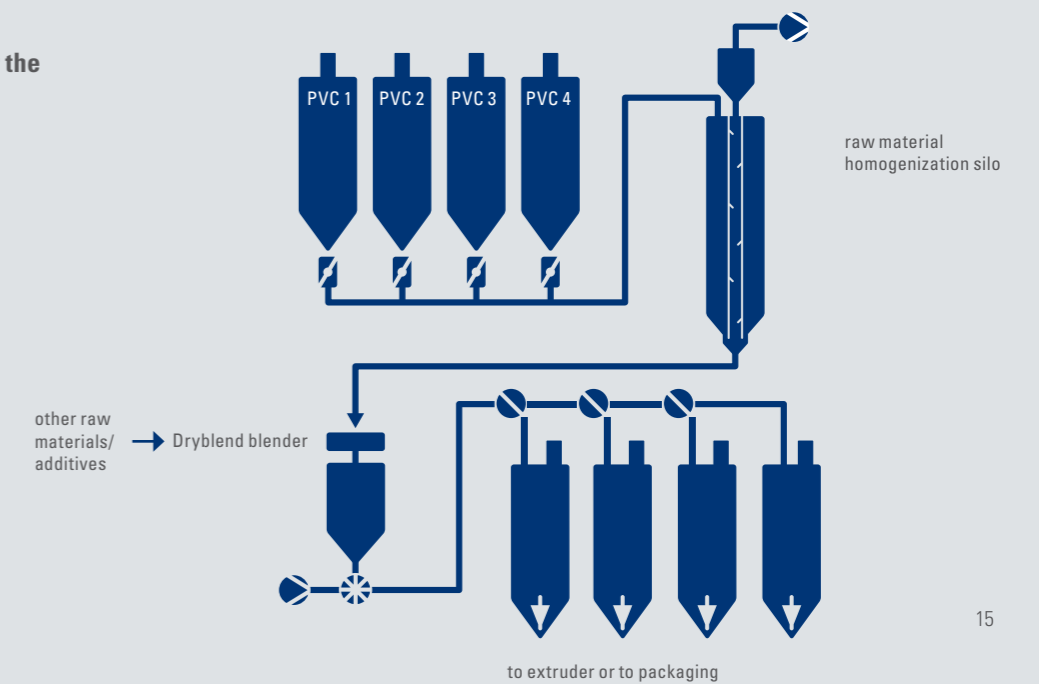



# Zeppelin Multi-Flow blending silo

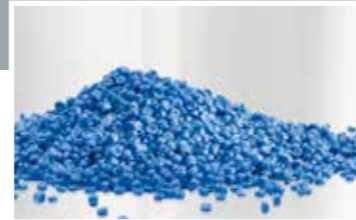

# Zeppelin Centro-Blend silo

### Applications

The versatile blender is suited for bulk materials with easy to poor flowability and is suitable both for continuous and discontinuous blending. The Multi-Flow blending silo is the ideal choice particularly for retrofitting conventional silos with blending technology.

### System description

The Zeppelin Multi-Flow blending hopper generates various flow velocities in the hopper and the lower cylinder area. This results in different dwelling times, which have an impact on the blending effect. Multi-Flow blending silos with a height-to-diameter ratio of  $< 2.5$  are particularly efficient. The Multi-Flow blending hopper can be installed in a new silo or retrofitted by means of flanging or welding. The support in the hopper is exclusively achieved by vertical flat fins, which facilitates cleaning.

### Advantages

- Existing silos can be retrofitted quickly and easily with this blending hopper
- The blending effect is achieved by means of a wide spread of dwelling times and mass flow
- No additional installations for an easy cleaning of the blending hopper
- Low-cost blender solution
- Small height due to inside blending chamber
- Discharge without residues
- Can be used in combination with degassing

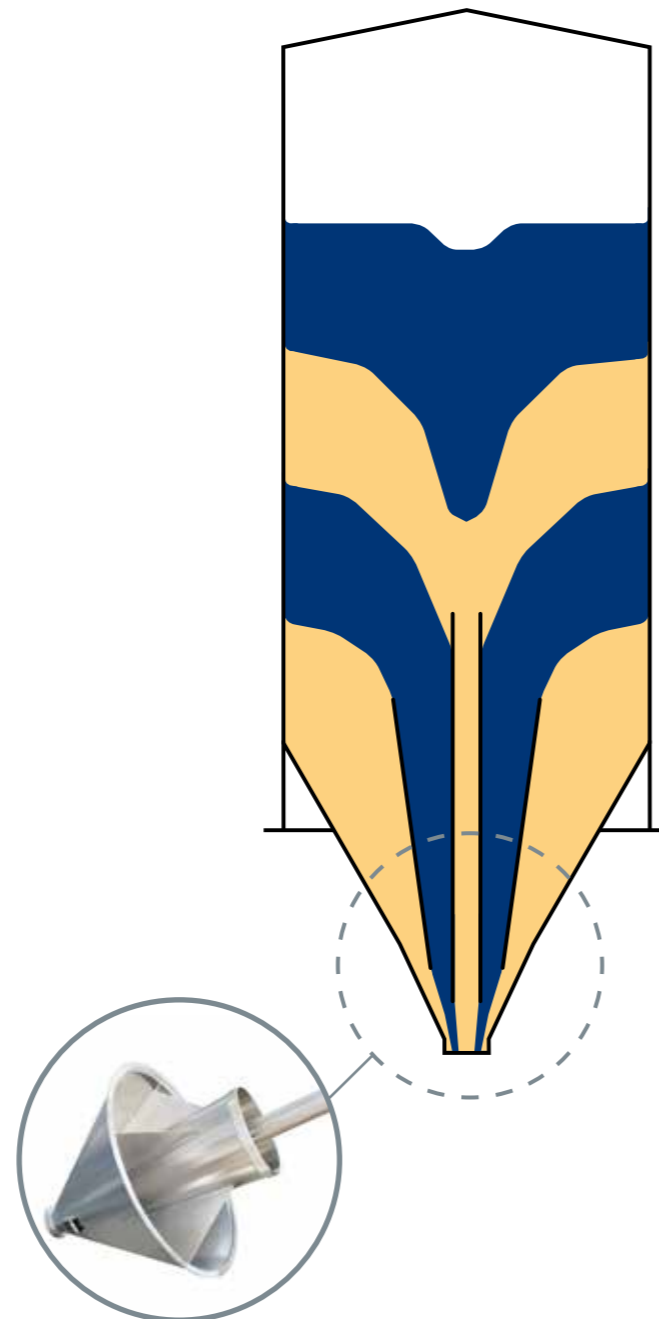

### Applications

With its large centrally-located blending pipe, the Centro-Blend also mixes bulk materials with poor flowability without problems. Plastic powders, recycling materials, pellets or free-flowing elastomers can be used. The blender is suited for continuous and discontinuous blending and is designed for volumes from 7 to 300 m<sup>3</sup>.

### System description

In the Centro-Blend, the bulk materials are simultaneously withdrawn through intake openings at various levels of a central blending pipe. Deflector plates in various sizes are welded above the intake openings ensuring that equal quantities are withdrawn from all layers. The product in the blending pipe is added to the product from the annular space in the blending chamber.

### Advantages

- No product residues and no dead zones due to the completely plane surfaces of the deflector plates
- Consistent design for mass flow
- Easy integration into the production process

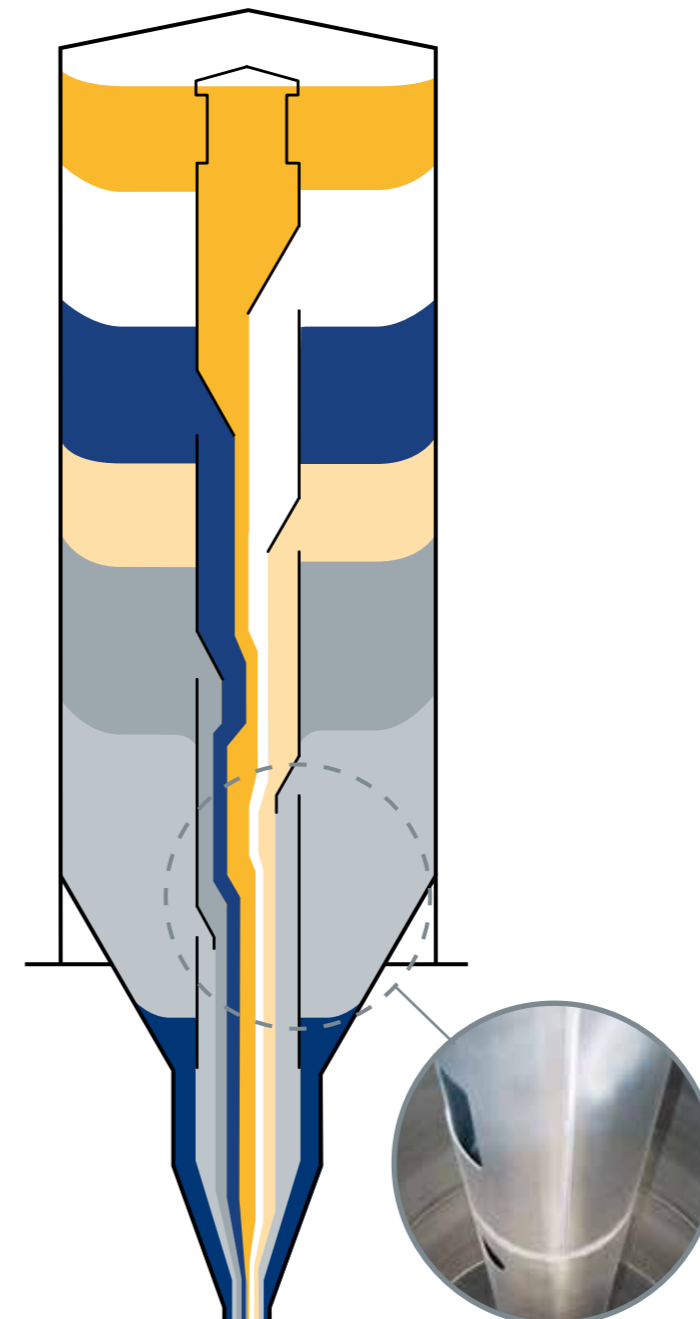

# Zeppelin Multi-Pipe and Multi-Channel blending silo



## Applications

The blenders are ideal for bulk materials with good flowability such as pellets with particle sizes of more than about 0.5 mm. They can be used for continuous and discontinuous blending.

## System description

The bulk materials are withdrawn by vertically running blending pipes inside the blending silo from 18 different levels at the same time and fed into the blending chamber. Inside the blending chamber, the 18 sub-jets are mixed with the product jet from the central outlet of the blender before being discharged. To achieve this result, 6 blending pipes with 3 compartments are used. The product at the blender outlet is a blend of the entire silo content.

## Advantages

- Homogenization of batches
- Can be used for different filling levels down to approx. 25%
- The design of the blending hopper for mass flow ensures good and reproducible homogenization results
- Easy integration into the production process
- A single cycle is often sufficient for many applications in continuous operation
- Discharge without residues
- Can be used in combination with degassing

## Additional advantages of the Multi-Channel blending silo

- Blending pipes are welded to the silo shell
- No additional fastenings are required for the blending pipes

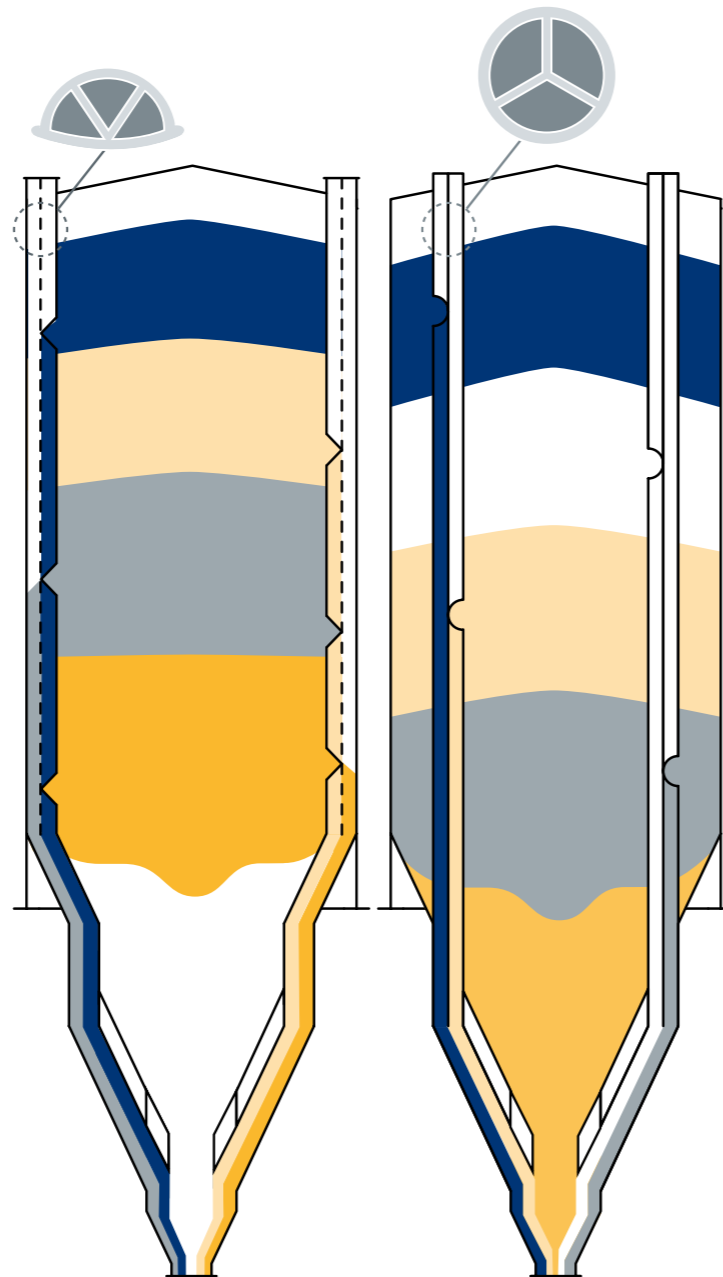

# Zeppelin Fluidized Bed Blender



## Applications

Fluidized bed blenders are suitable for blending of fluidizable bulk materials with particle sizes below 500 µm, particularly powders. It is used in batch operation.

## System description

Products are blended in the fluidized bed by means of random relative movement of the particles. In order to achieve this free motion, the bulk materials are perfused with the fluidization gas (usually air) and fluidized. By varying aeration of the different air inlets, horizontal blending can be increased. The blending effect can be optimized, and blending times can be reduced.

## Advantages

- Suitable for fluidizable powders
- Gentle homogenization since the individual particles are subject to virtually no external forces
- Suitable for bulk materials which are prone to breaking and abrasion
- Additional degassing products
- Blending of very large quantities of powder possible at minimum energy consumption

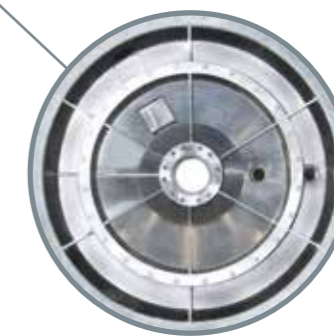
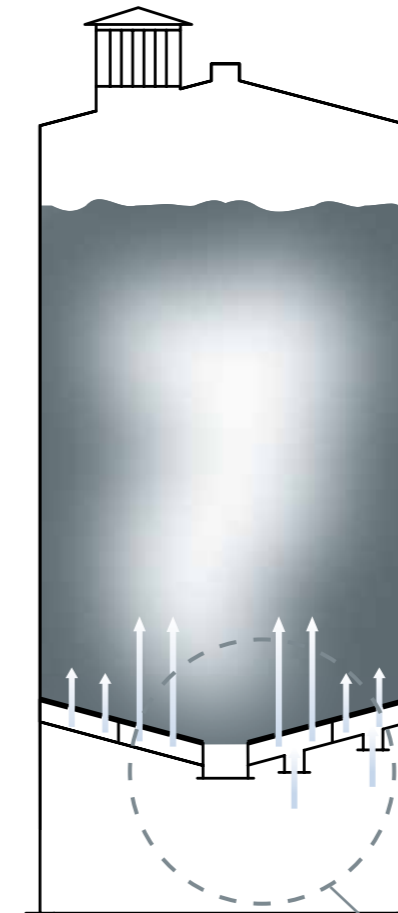

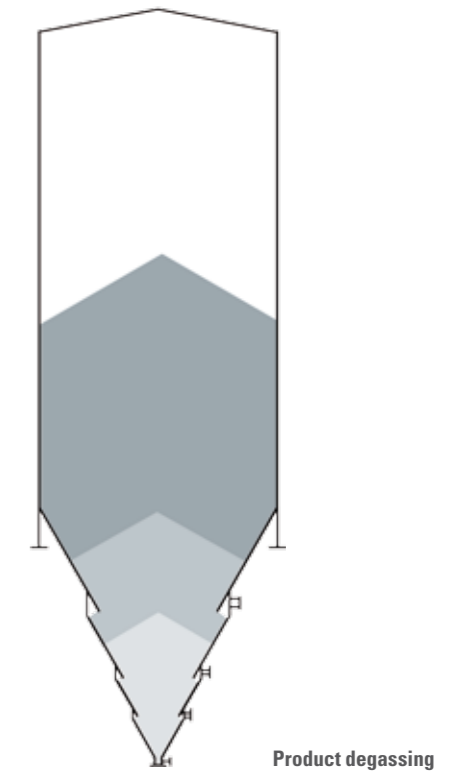

## SILOS IN PROCESS

Reliability in the daily use is of utmost importance in process silos. You can rely on the knowledge of Zeppelin process engineering silo specialists whatever the purpose of your application.

Whether degassing residual monomers, drying, heating or cooling within a silo or purge bin – the bulk material that requires procedural handling is in good hands with Zeppelin.

### Experts in the field

Silos can only be optimally designed for individual requirements with the necessary experience and a lot of process know-how. You can count on the world leading plant manufacturer's proficiency and the knowledge acquired through Zeppelin's bulk material network.

### Product degassing

Discharging residual monomers is an important production process step, particularly of LDPE, in order to reach the LEL (lower explosive limit). Whether purge bin or stepped cone silo, the design based on mass flow and no dead zones is the essential factor.

### Product heating/cooling

Heating or cooling a product during the process – or in combination with bulk material degassing – are further options to optimize processes.

### Product and flow properties

Every bulk material is different – what is important to know is how it reacts. Whether products with good or poor flowability, pellets or powders: we have the ideal solution for every product property.

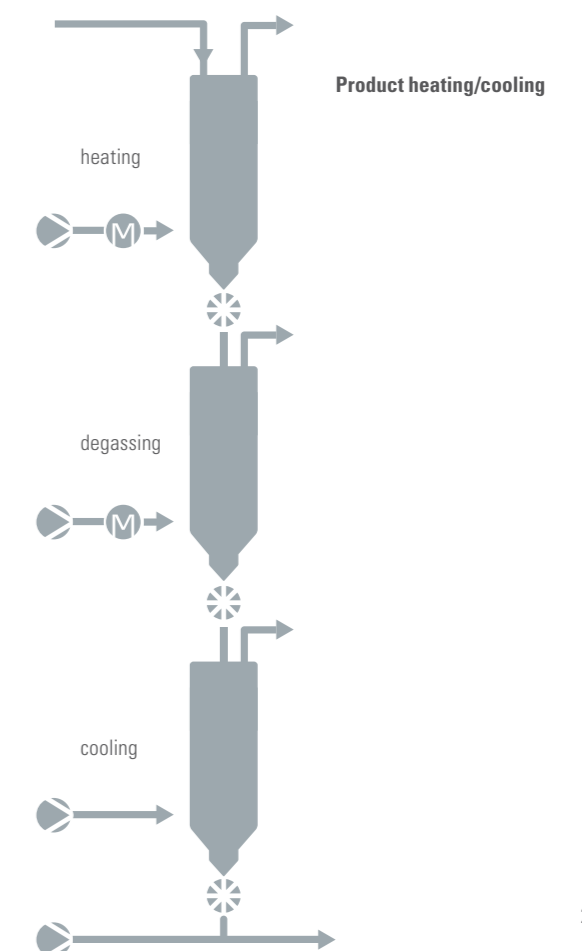
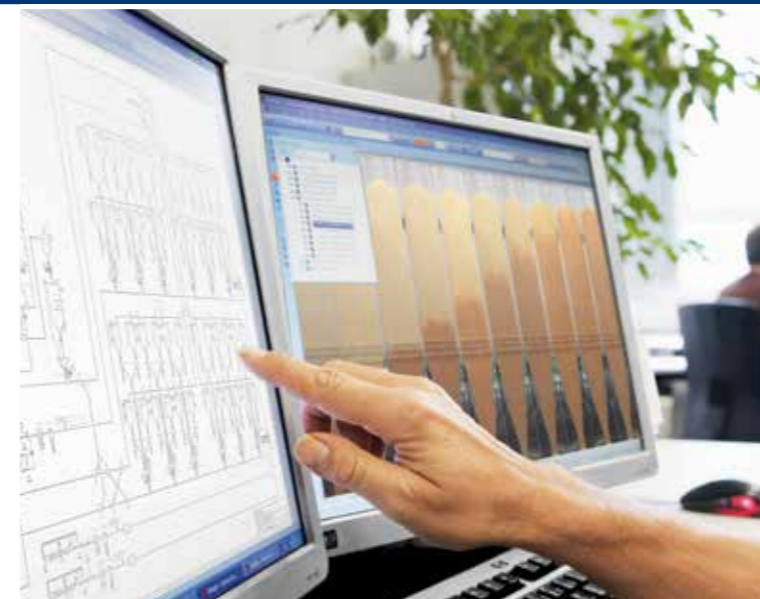

# THE TECHNOLOGY CENTER FOR PELLETS AND POWDERS



Customer inquiry

Our work, your advantages:

Ensure



## Reliability

The Zeppelin Technology Center in Friedrichshafen is equipped with all the necessary process technology components and systems. Our customers expect us to analyze their products in detail, as only those who know their bulk material well can design plants which are characterized by reliability, optimized processes, energy efficiency and cost efficient solutions.

## Process optimization

We conduct full scale tests to avoid the uncertainties of scale-up calculations. Special configurations can be quickly installed. Our experts provide you with a precise performance analysis as a solid basis for your investment decision.

## Energy efficiency

## Cost efficiency

Numerous modern test facilities guarantee optimum results. Data is continuously recorded by state-of-the-art measuring technology. We determine the relevant design parameters and issue detailed test reports as basis for designing your plant. We advise you in detail on all possibilities. New developments and advanced technologies are tested intensively.

Zeppelin customers have direct access to our technology centers to ensure the technological leadership essential for their operational success – wherever the location of the plant.

## Our services

### Conveying technology

- Dense phase and dilute phase conveying of pellets and powders
  - Nominal width: DN 65 – 225
  - Conveying distance: 10 – 460 m
  - Throughput: up to 200 t/h
- Hydraulic conveying of pellets
- Dense phase conveying of sensitive bulk material (bypass system)
- Combined vacuum and pressure conveying of pellets and powders
- Rotary feeders available in various sizes and types (high pressure, medium pressure and blow-through types)
- Pressure vessels
- Feeding systems: Pump-Flow or Screw-Flow

### Storage, discharge, blending and dosing technology

- Storage silos and vessels with various discharge systems
- Different blender types for powders and pellets
- Small component weighing unit for additives
- Heating and cooling of bulk material
- Degassing of bulk material

### Sorting, separating, cleaning

- Various separators for cleaning of pellets
- Drum screeners or streamer separators
- Pig system for pipe cleaning
- Various filter systems and cyclones

## COST-EFFICIENT VERSIONS

Various designs provide you with advantages regarding transport and assembly.

### Bolt-Tec

#### Bolting rather than welding

With our Bolt-Tec silos for volumes up to 1000 m<sup>3</sup>, we have made top quality even more cost-efficient. The automatic prefabrication of the silo segments allows short delivery times. They can be transported by ship in standard containers at little cost. They can also be transported at a reasonable cost via road with a curtainsider truck.

The silos can even be assembled when only little space is provided, e.g. inside buildings. The modular principle allows our customers to assemble their silos themselves.

**BOLT-TEC** 



### Panel-Tec

#### For silos larger than 500 m<sup>3</sup>

Panel-Tec silo segments are prefabricated in our manufacturing plant as well before they are transported to the site in containers and at little cost. Flange joints make it possible to quickly assemble and bolt together the modules. The silo can therefore be assembled in a short time. After that, the silos are welded automatically on the inside.

**PANEL-TEC** 



### Weld-Tec

#### Standard welded silos

Many customers prefer standard welded silos when the distance to the installation site is short or if the silo is relatively small. However, there are great differences in quality in this field. As a leading company in silo construction, Zeppelin guarantees premium long-term quality. If structural or process-related criteria (e.g. for process silos, due to design pressure/temperature, and for blending silos, due to diverse installations) make standard welded fabrication necessary, Weld-Tec is the best choice.

**WELD-TEC** 



# QUALITY HAS MANY DIFFERENT FACETS

In order to be able to produce long-term quality, many factors have to be right. Zeppelin applies the highest standards in all areas to achieve this goal. State-of-the-art production processes ensure top-class quality.

## One weld joint is not like the other

Only the most skilled employees do welding work here. That is why only TÜV-certified welders are employed at Zeppelin. Made in Germany always pays off. Of course, we have all the important and relevant certifications for welding and processing technology.

## Know-how

Zeppelin brings together plenty of knowhow. We have one of the largest bulk material libraries in the world. At our globally-leading technology center, tests on a scale of 1:1 can be performed.

## Innovation edge

Zeppelin owns many patents from which our customers benefit. Special machines for circular form bending of cones, simultaneous two-sided welding, the new modular system: this is how quality is achieved in a cost-efficient way.

## Service – service – service

As a system supplier, we deliver turn-key plants for the plastics processing and plastics producing industry. You obtain everything from a single source, from consulting, engineering and production to commissioning. And it doesn't stop there. Modification, repair work, change of location, spare parts service, etc. You can always count on us.



Trust is good – certifications are better! Zeppelin disposes of all certificates, licenses and accreditations





## Presented by:

Zeppelin Systems GmbH  
Graf-Zeppelin-Platz 1  
88045 Friedrichshafen  
Germany

Tel.: +49 7541 202 - 02  
Fax: +49 7541 202 - 1491

zentral.fn@zeppelin.com  
www.zeppelin.com

For the complete Zeppelin Systems range please visit our website at  
[www.zeppelin-systems.com](http://www.zeppelin-systems.com)

## Global presence

- Australia
- Belgium
- Brazil
- China
- France
- Germany
- India
- Italy
- Korea
- Russia
- Saudi Arabia
- Singapore
- United Kingdom
- USA